

Vector Signal Analyzer R&S FSQ-K70

Universal demodulation, analysis and documentation of digital radio signals

- ◆ For all major mobile radio communication standards:
 - GSM & EDGE
 - WCDMA-QPSK
 - CDMA2000-QPSK
 - *Bluetooth*[™]
 - TETRA
 - PDC
 - PHS
 - DECT
 - NADC
- ◆ For all common digital modulation modes:
 - BPSK, QPSK, OQPSK
 - $\pi/4$ DQPSK
 - 8PSK, D8PSK, $3\pi/8$ 8PSK
 - (G)MSK
 - 2, 4, (G)FSK
 - 16, 32, 64, 128, 256 (D)QAM
 - ◆ 20.4 MHz symbol rate
 - ◆ 28 MHz I/Q demodulation bandwidth
- ◆ Optimum representation of results:
 - In-phase and quadrature signals versus time
 - Magnitude and phase versus time
 - Eye diagram
 - Vector diagram
 - Constellation diagram
 - Table with modulation errors
 - Demodulated bit stream
 - Statistical evaluation of modulation parameters
 - Amplifier distortion measurements



ROHDE & SCHWARZ

Universal analysis of digital radio signals

The vector signal analyzer option upgrades the high-quality Signal Analyzers R&S FSQ, adding universal demodulation and analysis capability down to bit stream level for digital radio signals. The option supports all common mobile radio communication standards.

Measurement and analysis of digital modulation signals

You want to measure and analyze digitally modulated signals? This can easily be done even up to 26 GHz with the vector signal analyzer option in the R&S FSQ.

In addition to performing standard measurements such as determination of modulation accuracy, carrier leakage or I/Q imbalance, you can also study the information statistics of these parameters such as the standard deviation of carrier frequency error calculated over 10 measurements.

Since the R&S FSQ-K70 can analyze digital signals, it is an ideal tool for use in development and production

Versatile in the lab

You may want to develop future or company standards, use unconventional formats or modify synchronization sequences.

In all these cases, the R&S FSQ with the option R&S FSQ-K70 will support you by providing user-selectable bit and symbol rates, filters, modulation schemes and synchronization sequences. You can even generate and store your own generic standards, save the settings and recall them at any time.

Efficient in production

The high measurement speed of 60 sweeps/s in the analyzer mode and typically 20 measurements/s using the vector signal analyzer function is ideal for applications in production. The high flexibility allows multistandard test systems to be configured for easy adaptation to varying production requirements.

Any mobile radio standard at a key stroke

The high flexibility offered by the analyzer is by no means at the price of complicated operations: all major digital modulation standards can be activated at a key stroke. The instrument is then completely configured for measurements in line with the activated standard. The corresponding synchronization sequences are of course offered along with the standard.

Multiple test functions integrated in one unit

The Signal Analyzers R&S FSQ in conjunction with the option R&S FSQ-K70 replace several individual instruments:

- ◆ High-grade spectrum analyzer
- ◆ Vector demodulator
- ◆ Constellation analyzer

Principle of vector signal analysis

The IF signal is digitized by means of a fast A/D converter, allowing purely digital processing of all subsequent analysis steps, thus making them practically error-free and providing high long-term and temperature stability. After A/D conversion, the signal is digitally mixed into the baseband and split into a real and an imaginary component. The complete signal information is thus available for further analysis.

BLUETOOTH is a trademark owned by Bluetooth SIG, Inc., USA and licensed to Rohde & Schwarz

GENERIC STANDARD	STANDARD
3G_WCDMA	3G_WCDMA_FWD
BLUETOOTH	3G_WCDMA_FWD
CDMA2K	3G_WCDMA_REV
DECT	BLUETOOTH_LDH1
GSM-EDGE	BLUETOOTH_LDH3
NADC	BLUETOOTH_LDH5
PDC	CDMA2K_1X_FWD
PHS	CDMA2K_1X_REV
TETRA	DECT_FFP
(ALL)	EDGE_NB
	GSM_LAB
	GSM_LFB
	GSM_LNB
	GSM_LSB
	NADC_FWD
	NADC_REV
	PDC_DOWN
	PDC_UP
	<DOWN>

List of standards

The signal is demodulated down to bit level by a DSP. From the data stream thus obtained, an ideal signal is calculated. This reference signal is compared with the test signal. The resulting difference signal contains all modulation errors (see block diagram below).

The R&S FSQ features a newly developed digital back end that benefits from the progress in ADC and ASIC development. Time-consuming evaluation algorithms can be implemented directly in hardware – a prerequisite for fast measurement and high accuracy.

- ◆ 14-bit A/D converter 81.6 MHz
- ◆ Digital hardware resampler to match the sampling rate to a multiple of the symbol rate
- ◆ Sampling rate from 10 kHz to 81.6 MHz adaptable to the modulation rate
- ◆ SFDR >80 dBfs
- ◆ Digital downconversion to baseband with high output bandwidth (28 MHz referred to RF)

Visualizing amplifier influence on your signal

By analyzing the difference between the reference signal and the signal under test, the analyzer can display the distribution of the amplitude and phase error as a probability density function.

Furthermore, the phase and amplitude errors can be analyzed with respect to signal amplitude. The results can reveal the cause of modulation errors and help finding the optimum operating point for the amplifier.

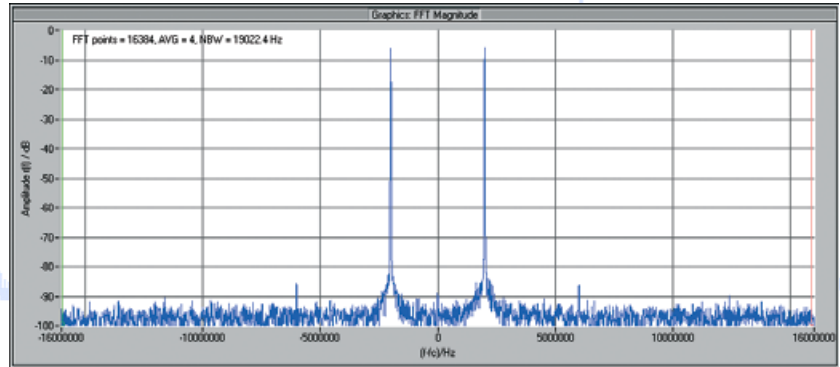

Intermodulation distortion of I/Q data: a distortion-free transmission range is particularly important for amplifier measurements; the illustration above shows the intermodulation characteristics of the I/Q data of a two-tone signal.

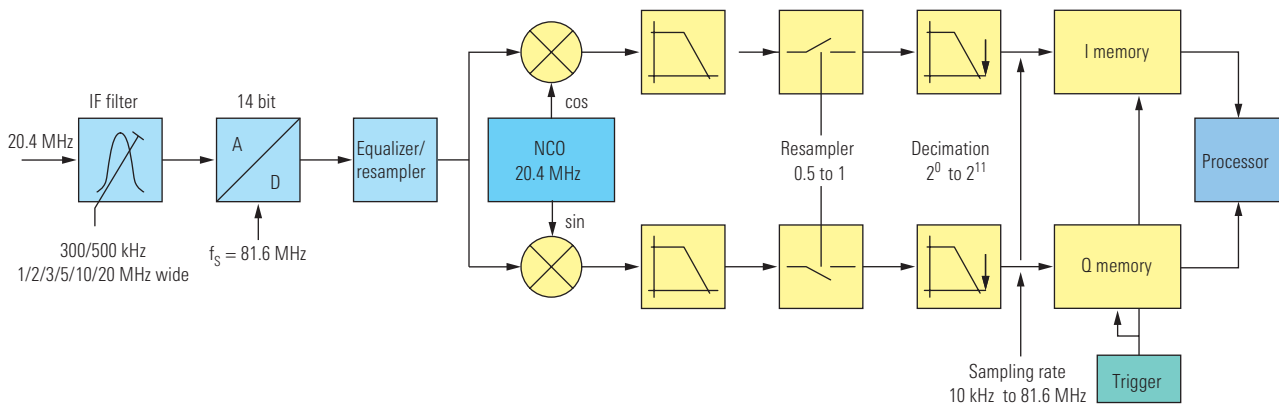

Block diagram of vector signal analysis section in the R&S FSQ

Applications

Measurements on parts of signals (1)

To perform these measurements on TDMA systems such as EDGE in line with standards, a time reference must be established from synchronization sequences to pre- or midamble. This is done in the PATTERN SEARCH mode, in which the analyzer triggers on preset or user-defined synchronization sequences. This not only allows established standards to be measured with high precision, but also modified settings in the case of new developments. Further trigger modes are:

- ◆ External
- ◆ Burst

Picture 1 shows an example where the modulation quality is measured only on the training sequence of an EDGE signal.

Modulation accuracy measurements on WCDMA mobiles (2 and 3)

The low inherent EVM of <0.6% (rms) of the option R&S FSQ-K70 substantially reduces uncertainty. Tolerances, e.g. an rms EVM error of 17.5% for WCDMA, can thus be allowed practically completely for the DUT, thus widening the DUT tolerance margin.

The SYMBOL TABLE/MODULATION ACCURACY lists the demodulated bits and the errors found. The bit sequences and the errors can be read via the fast

IEC/IEEE bus or 100 Mbit LAN connection of the analyzer.

The constellation diagram of the QPSK signal and the probability distribution of the amplitudes are shown below.

Modulation error measurements on EDGE signals (4)

The upper screen (A) shows the EVM versus time of an EDGE signal; the lower screen provides a summary of relevant errors measured over a burst signal and several statistical parameters calculated over 10 bursts.

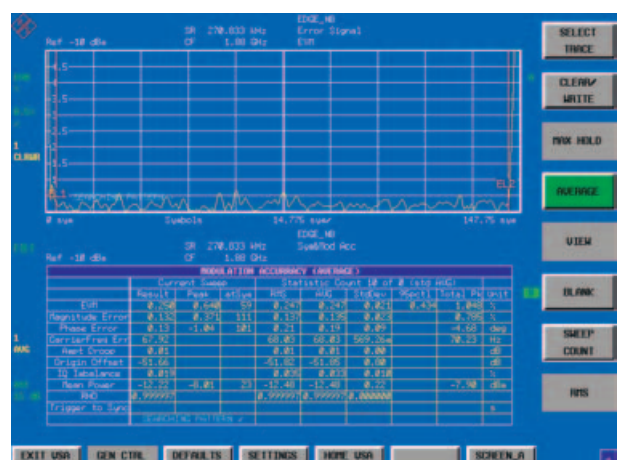
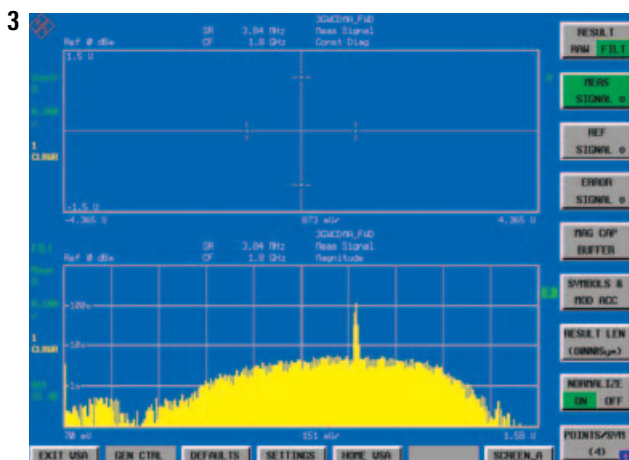
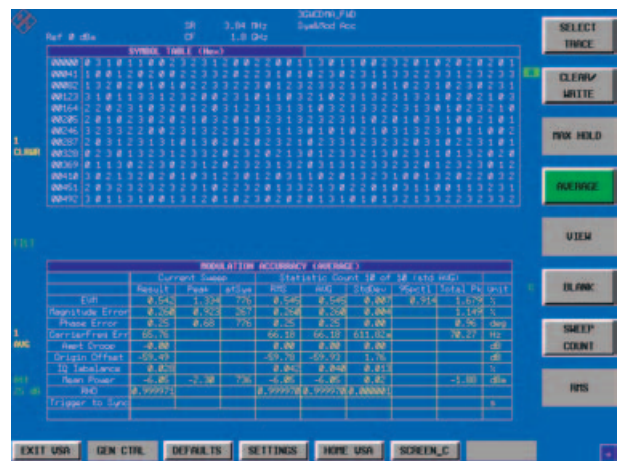

Convenient analysis with vector diagram (5)

The vector diagram enables convenient analysis of the degradation of modulation accuracy caused, for example, by nonlinearities, phase noise or amplitude-dependent phase response of amplifiers, converters, etc. The upper screen (A) shows the complete constellation diagram, the lower screen (B) the probability distribution of the error vector magnitude (EVM).

AM/φM and AM/AM distortion example with a 16 QAM signal (6 and 7)

Picture 6 shows the constellation diagram where the outer constellation points are drawn to the center of the diagram as a result of the amplifier compression. Picture 7 shows the AM/AM and AM/φM conversion curve of the same signal.

WLAN 802.11b constellation diagram (8)

Signals where the modulation format changes the signal quality can be analyzed with the R&S FSQ-K70. The constellation diagram in the upper half of the display is calculated from the QPSK part of an 802.11b signal marked with the red display lines. Due to the Gaussian pulse shaping filter used by the transmitter, the signal is not intersymbol-interference-free and the symbol points are not single points but are distributed in a square.

Specifications for R&S FSQ-K70 see PD 0757.8313.

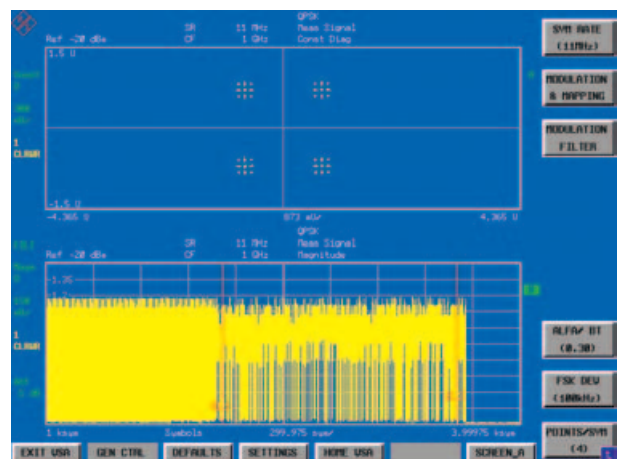
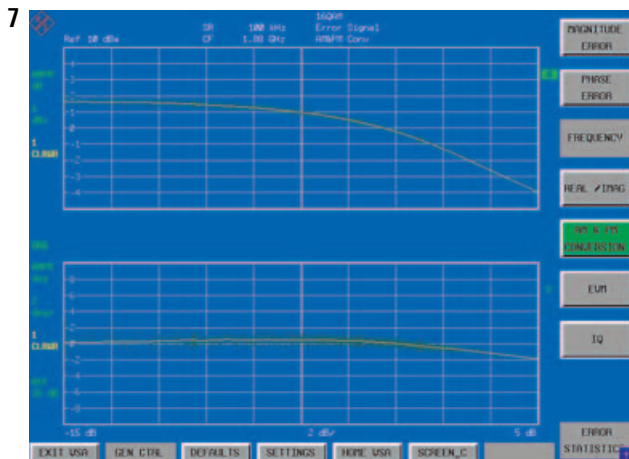
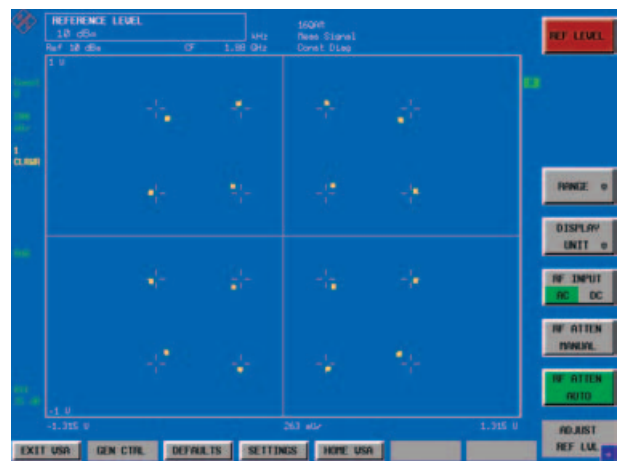
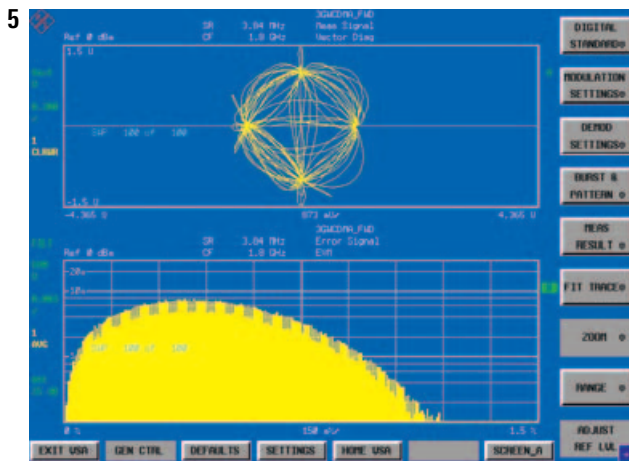

Certified Environmental System
ISO 14001
REG. NO 1954

Certified Quality System
ISO 9001
DQS REG. NO 1954

